

# Technical drawing Sita**Standard** Fluid vertical DN 150

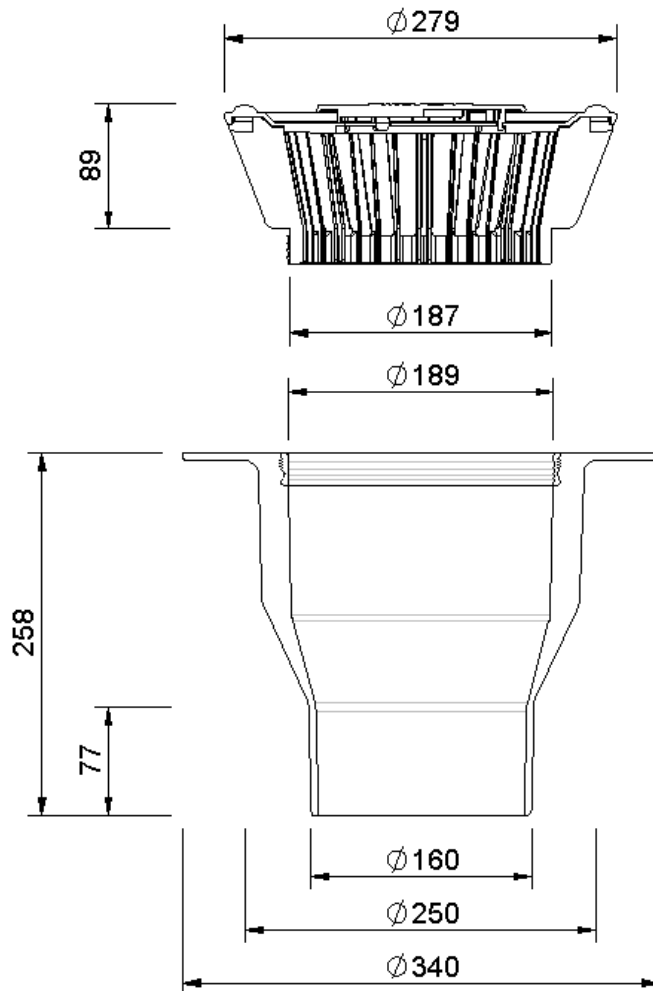

SitaStandard Fluid vertical DN 150, with Adhesive flange  
heated

Article number  
100990

Changes possible due to technical development, subject to mistakes and printing errors.

Sita Bauelemente GmbH \* Ferdinand-Braun-Strasse 1 \* 33378 Rheda-Wiedenbrück, Germany \* Tel +49 2522 8340-0 \* Fax +49 2522 8340-100 \* info@sita-bauelemente.de \* www.sita-bauelemente.de