

# Technical drawing Sita**DSS** Indra

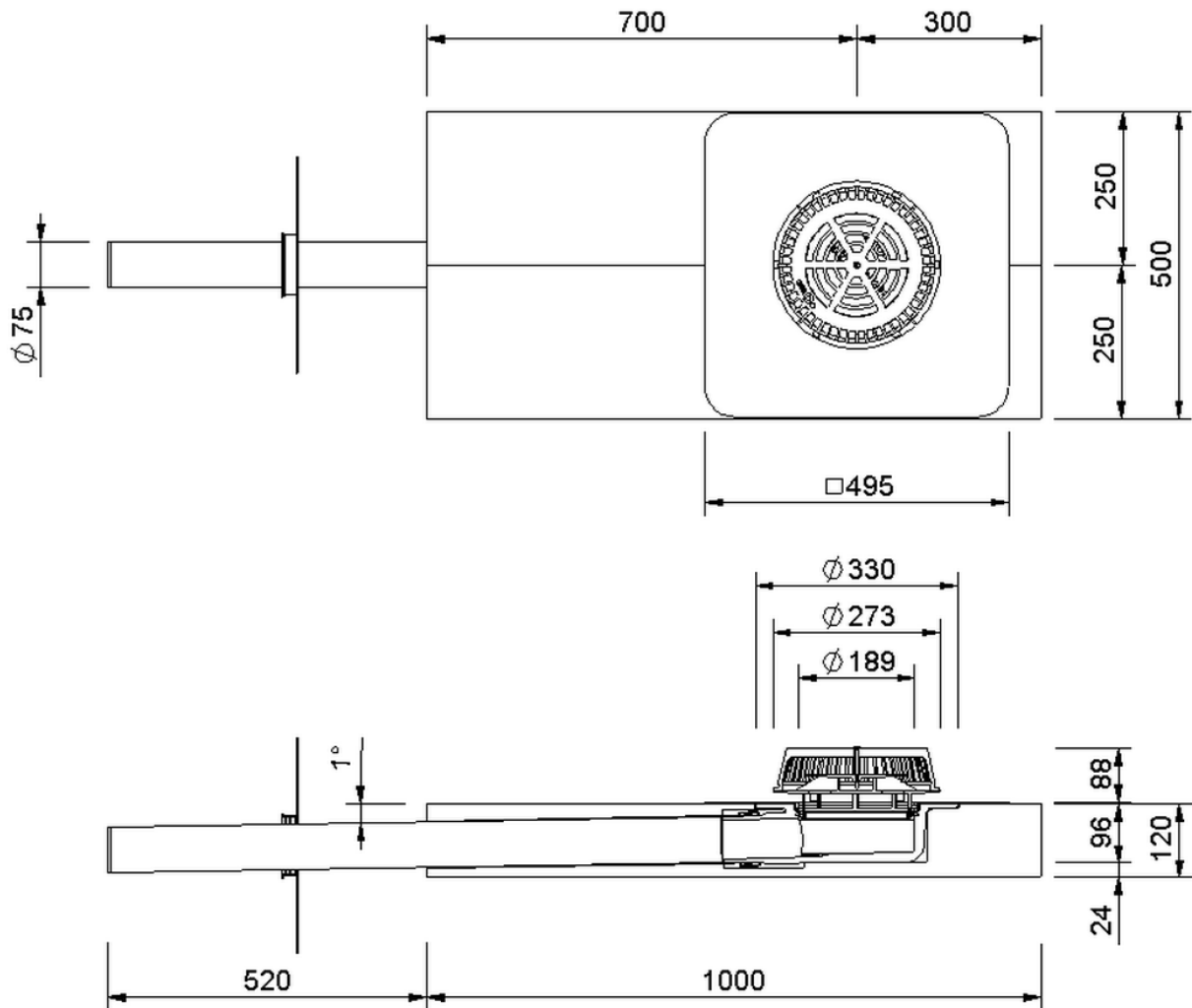

SitaDSS Indra, with bitumen-sleeve  
3.0 metre fall pipe

Article number  
148500

Changes possible due to technical development, subject to mistakes and printing errors.

Sita Bauelemente GmbH \* Ferdinand-Braun-Strasse 1 \* 33378 Rheda-Wiedenbrück, Germany \* Tel +49 2522 8340-0 \* Fax +49 2522 8340-100 \* info@sita-bauelemente.de \* www.sita-bauelemente.de