

Technical drawing

Sita**Turbo** Max with loose flange as a retaining element

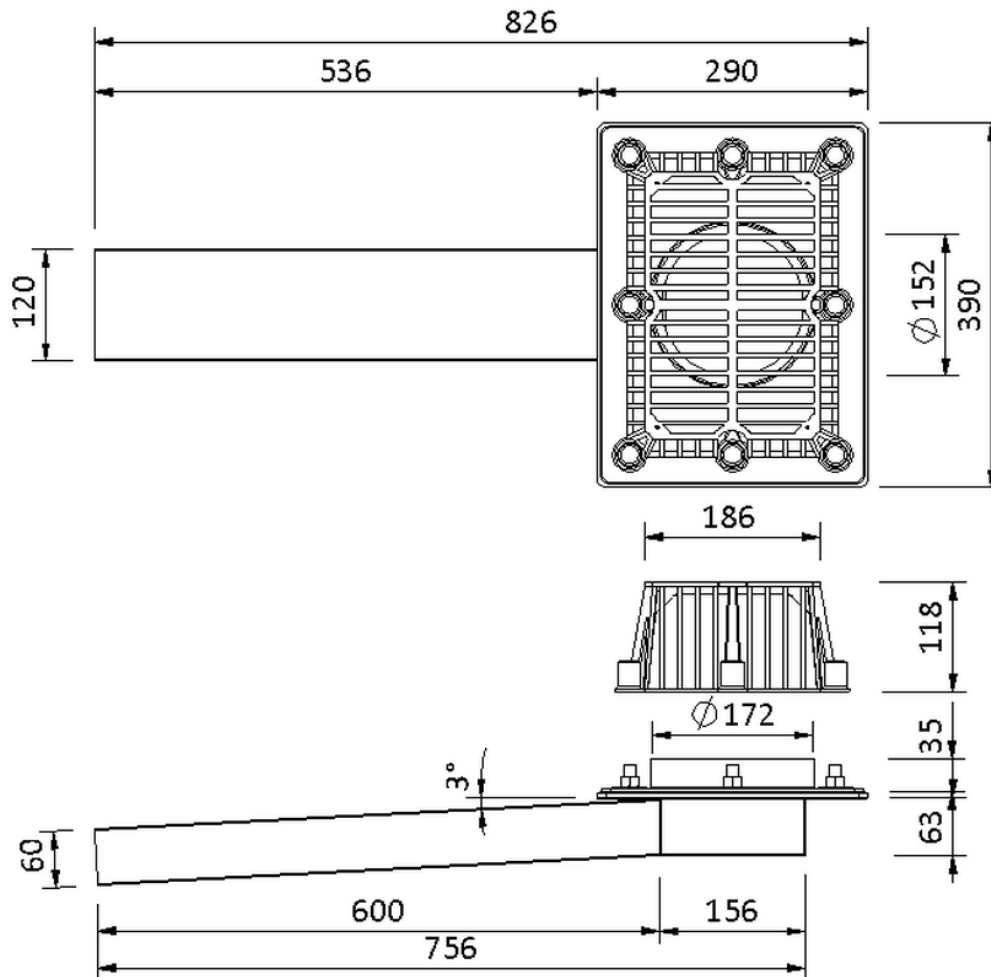

SitaTurbo Max with loose flange as a retaining element, pipe length
600 mm
35 mm

Article number
18063599

Changes possible due to technical development, subject to mistakes and printing errors.

Sita Bauelemente GmbH * Ferdinand-Braun-Strasse 1 * 33378 Rheda-Wiedenbrück, Germany * Tel +49 2522 8340-0 * Fax +49 2522 8340-100 * info@sita-bauelemente.de * www.sita-bauelemente.de