

Technical drawing

SitaPipe stainless steel transition piece eccentric, DN 40 to DN 50

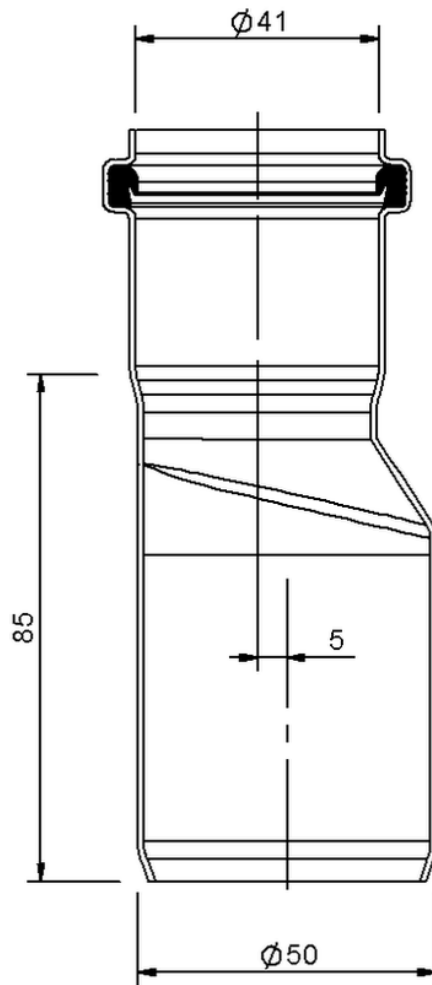

SitaPipe stainless steel transition piece eccentric, DN 40 to DN 50,
DIN EN 1124

Article number

70015040

Changes possible due to technical development, subject to mistakes and printing errors.

Sita Bauelemente GmbH * Ferdinand-Braun-Strasse 1 * 33378 Rheda-Wiedenbrück, Germany * Tel +49 2522 8340-0 * Fax +49 2522 8340-100 * info@sita-bauelemente.de * www.sita-bauelemente.de