

Technical drawing

Sita**Pipe** stainless steel bend 45°, DN 80

---

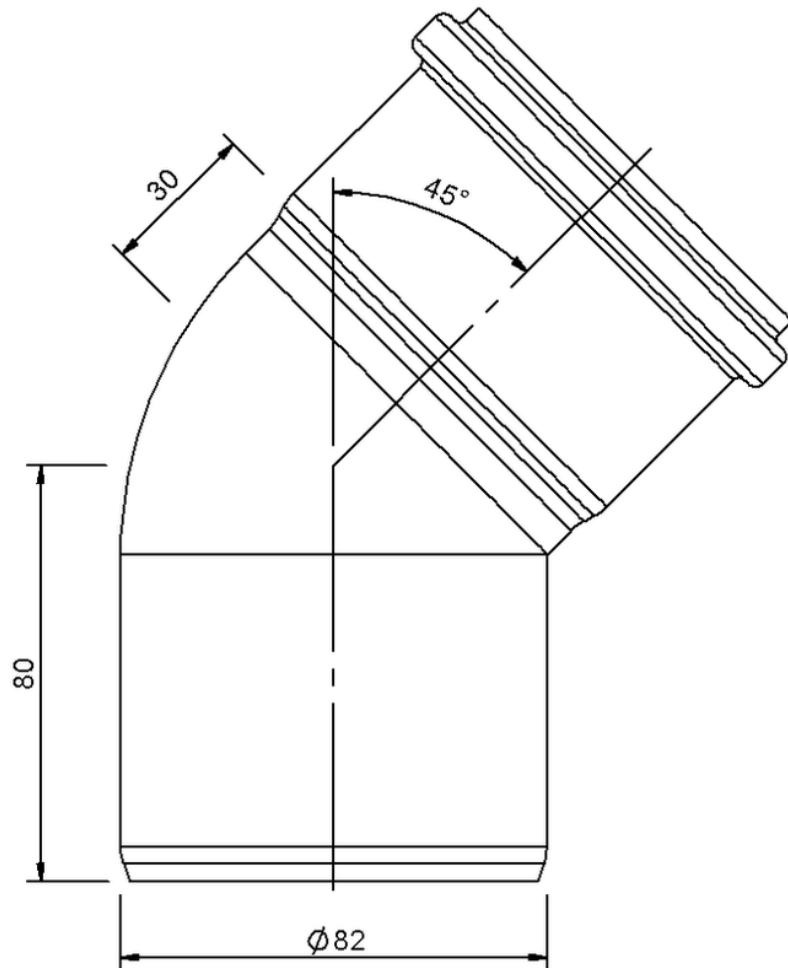

---

SitaPipe stainless steel bend 45°, DN 80, DIN EN 1124

Article number

70044580

Changes possible due to technical development, subject to mistakes and printing errors.

Sita Bauelemente GmbH \* Ferdinand-Braun-Strasse 1 \* 33378 Rheda-Wiedenbrück, Germany \* Tel +49 2522 8340-0 \* Fax +49 2522 8340-100 \* info@sita-bauelemente.de \* www.sita-bauelemente.de